

ULTRAoutdoor

THICKNESS 2 cm - 3 cm #2026



ULTRAoutdoor

THICKNESS 2 cm - 3 cm

INTRODUZIONE INTRODUCTION	02
MATERIA THE MATERIAL	04
I VANTAGGI ADVANTAGES	06
AMBIENTAZIONI SPACES	08
SOSTENIBILITÀ SUSTAINABILITY	10
COLORI E FORMATI COLORS AND SIZES	12
EFFETTO PIETRA STONE LOOK	14
EFFETTO CEMENTO CONCRETE LOOK	34
EFFETTO LEGNO WOOD LOOK	42
GAMMA COMPLETA ULTRA OUTDOOR ULTRA OUTDOOR COMPLETE RANGE	48
IMBALLI PACKAGING	49
PEZZI SPECIALI SPECIAL PIECES	50
SISTEMI DI POSA INSTALLATION SYSTEMS	56
CARATTERISTICHE TECNICHE TECHNICAL FEATURES	64

La nuova dimensione dell'abitare all'aperto.

The new dimension of outdoor living.





INTRODUCTION

Un nuovo modo di vivere gli spazi esterni.

Ultra Outdoor nasce per ridefinire il concetto di spazio esterno. Una collezione completa di superfici in gres porcellanato rettificato pensata per chi progetta terrazze, giardini, spazi urbani e ambienti pubblici in cui design e prestazioni convivono in perfetto equilibrio. Ogni lastra è il risultato di una tecnologia avanzata che garantisce resistenza, stabilità e bellezza duratura. Con spessori di 2 cm e 3 cm, Ultra Outdoor è la soluzione ideale per chi cerca continuità estetica tra interno ed esterno e materiali capaci di resistere nel tempo, senza compromessi.

A new way of experiencing outdoor spaces.

Ultra Outdoor was created to redefine the concept of outdoor living. A complete collection of rectified porcelain stoneware surfaces, designed for terraces, gardens, urban spaces and public areas, where design and performance coexist in perfect balance. Each slab is the result of advanced technology that ensures strength, stability and long-lasting beauty.

With thicknesses of 20 mm and 30 mm, Ultra Outdoor is the ideal solution for those seeking aesthetic continuity between indoor and outdoor spaces and materials that stand the test of time, without compromise.

Une nouvelle façon de vivre les espaces extérieurs.

Ultra Outdoor est née pour redéfinir le concept d'espace outdoor. Une collection complète de surfaces en grès cérame rectifié, pensée pour les terrasses, les jardins, les espaces urbains et les environnements publics, où design et performances coexistent en parfait équilibre. Chaque dalle est le résultat d'une technologie avancée garantissant résistance, stabilité et beauté durable. Avec des épaisseurs de 20 mm et 30 mm, Ultra Outdoor est la solution idéale pour ceux qui recherchent une continuité esthétique entre intérieur et extérieur et des matériaux capables de résister dans le temps, sans compromis.

Eine neue Art, Außenbereiche zu erleben.

Ultra Outdoor wurde entwickelt, um das Konzept des Außenraums neu zu definieren. Eine umfassende Kollektion rektifizierter Feinsteinzeugoberflächen, konzipiert für Terrassen, Gärten, urbane Bereiche und öffentliche Räume, in denen Design und Leistungsfähigkeit in perfektem Gleichgewicht stehen. Jede Platte ist das Ergebnis fortschrittlicher Technologie und garantiert Widerstandsfähigkeit, Stabilität und dauerhafte Schönheit. Mit Stärken von 2 cm und 3 cm ist Ultra Outdoor die ideale Lösung für alle, die eine ästhetische Kontinuität zwischen Innen- und Außenbereichen sowie langlebige Materialien ohne Kompromisse suchen.

L'essenza della ceramica italiana

Realizzate con argille, quarzi e feldspati selezionati, le superfici Ultra Outdoor nascono da un processo di cottura a oltre 1200 °C, che fonde in modo irreversibile le materie prime in un'unica massa compatta. Il risultato è un materiale impenetrabile, a basso assorbimento e ad altissima resistenza meccanica, perfetto per affrontare gli agenti atmosferici e il passare del tempo. Ogni piastrella è ecocompatibile e completamente riciclabile, a testimonianza dell'impegno di Antica Ceramica Rubiera verso una produzione responsabile e sostenibile.

The essence of Italian ceramics.

Made from selected clays, quartz and feldspars, Ultra Outdoor surfaces are produced through a firing process at over 1200 °C, which irreversibly fuses the raw materials into a single compact body. The result is an impermeable material with low water absorption and extremely high mechanical strength, ideal for withstanding weather conditions and the passage of time. Each tile is eco-friendly and fully recyclable, reflecting Antica Ceramica Rubiera's commitment to responsible and sustainable production.

L'essence de la céramique italienne.

Réalisées à partir d'argiles, de quartz et de feldspaths sélectionnés, les surfaces Ultra Outdoor sont issues d'un processus de cuisson à plus de 1200 °C, qui fusionne de manière irréversible les matières premières en une masse unique et compacte. Le résultat est un matériau imperméable, à faible absorption d'eau et à très haute résistance mécanique, parfaitement adapté aux agents atmosphériques et à l'épreuve du temps. Chaque carreau est écoresponsable et entièrement recyclable, témoignant de l'engagement de Antica Ceramica Rubiera en faveur d'une production responsable et durable.

Die Essenz italienischer Keramik.

Hergestellt aus ausgewählten Tonen, Quarzen und Feldspäten entstehen die Oberflächen Ultra Outdoor durch einen Brennprozess bei über 1200 °C, der die Rohstoffe irreversibel zu einer einzigen kompakten Masse verschmilzt. Das Ergebnis ist ein undurchlässiges Material mit geringer Wasseraufnahme und äußerst hoher mechanischer Widerstandsfähigkeit, ideal für die Einwirkung von Witterungseinflüssen und den Lauf der Zeit. Jede Fliese ist umweltfreundlich und vollständig recycelbar – ein Beleg für das Engagement von Antica Ceramica Rubiera für eine verantwortungsvolle und nachhaltige Produktion.





Bellezza, sicurezza, durata. In ogni condizione.

Ultra Outdoor unisce la robustezza tecnica di un materiale industriale all'eleganza naturale delle superfici che arredano.

Beauty, safety, durability. In every condition.

Ultra Outdoor combines the technical robustness of an industrial material with the natural elegance of surfaces designed to enhance outdoor spaces.

Beauté, sécurité, durabilité. En toutes circonstances.

Ultra Outdoor associe la robustesse technique d'un matériau industriel à l'élégance naturelle de surfaces conçues pour aménager les espaces extérieurs.

Schönheit, Sicherheit, Langlebigkeit. Unter allen Bedingungen.

Ultra Outdoor vereint die technische Robustheit eines industriellen Materials mit der natürlichen Eleganz von Oberflächen, die Außenbereiche gestalten.

ADVANTAGES

Antiscivolo R11: ideale per ambienti esposti all'acqua e all'umidità.
R11 Anti-slip: ideal for areas exposed to water and humidity.
Antidérapant R11 : idéal pour les environnements exposés à l'eau et à l'humidité.
Rutschhemmung R11: ideal für Bereiche, die Wasser und Feuchtigkeit ausgesetzt sind.



Resistente al gelo e agli sbalzi termici: dalle temperature più rigide al sole più intenso.
Frost- and thermal-shock resistant: from extreme cold to intense sunlight.
Résistant au gel et aux chocs thermiques : des températures les plus basses au soleil le plus intense.
Frost- und temperaturwechselbeständig: von extremen Kältebedingungen bis zu intensiver Sonneneinstrahlung.



Inattaccabile da agenti chimici e macchie: perfetta per spazi pubblici e privati.
Resistant to chemicals and stains: perfect for both public and private spaces.
Résistant aux agents chimiques et aux taches : parfait pour les espaces publics et privés.
Beständig gegen Chemikalien und Flecken: ideal für private und öffentliche Bereiche.



Facile da pulire: non richiede trattamenti protettivi o manutenzioni stagionali.
Easy to clean: no protective treatments or seasonal maintenance required.
Facile à nettoyer : ne nécessite aucun traitement de protection ni entretien saisonnier.
Pflegeleicht: keine Schutzbehandlungen oder saisonale Wartung erforderlich.



Modulare e rettificato: per una posa precisa e armoniosa.
Modular and rectified: for precise and harmonious installation.
Modulaire et rectifié : pour une pose précise et harmonieuse.
Modular und rektifiziert: für eine präzise und harmonische Verlegung.

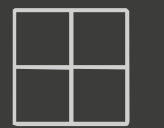

Made in Italy: progettato, prodotto e controllato interamente in Italia.
Made in Italy: entirely designed, manufactured and quality-controlled in Italy.
Made in Italy : entièrement conçu, fabriqué et contrôlé en Italie.
Made in Italy: vollständig in Italien entworfen, produziert und kontrolliert.



Eco sostenibile: riduzione costante delle emissioni e dei consumi energetici
Eco-sustainable: continuous reduction of emissions and energy consumption.
Écoresponsable : réduction continue des émissions et de la consommation énergétique.
Nachhaltig: kontinuierliche Reduzierung von Emissionen und Energieverbrauch.



Resistente ai carichi: può sopportare un carico di oltre 1.000 kg per lastra.
Load resistant: capable of supporting loads exceeding 1,000 kg per slab.
Résistant aux charges : supporte des charges supérieures à 1,000 kg par dalle.
Hohe Belastbarkeit: trägt eine Last von über 1.000 kg pro Platte.



Spazi che dialogano con la natura.

Ultra Outdoor interpreta la materia come elemento architettonico.

Le superfici, ispirate alle pietre naturali e ai cementi contemporanei, diventano parte del paesaggio: pavimentazioni, rivestimenti, scalinate, bordi piscina, camminamenti.

Ogni ambiente è un progetto di equilibrio tra design e funzionalità:

- Terrazze e patii: superfici uniformi, eleganti, confortevoli al calpestio.
- Giardini e camminamenti: soluzioni su erba o ghiaia per percorsi naturali.
- Piscine e spa: pavimentazioni antiscivolo e coordinate con i bordi vasca.
- Spazi pubblici e aree urbane: superfici durevoli, resistenti e facilmente manutenibili.

Spaces that connect with nature.

Ultra Outdoor interprets material as an architectural element. Surfaces inspired by natural stone and contemporary concrete become an integral part of the landscape: flooring, wall cladding, staircases, pool edges and walkways.

Each setting is a balanced project of design and functionality:

- **Terraces and patios:** uniform, elegant surfaces with a comfortable underfoot feel.
- **Gardens and walkways:** solutions for installation on grass or gravel, creating natural paths.
- **Pools and spas:** anti-slip flooring coordinated with pool edges.
- **Public spaces and urban areas:** durable, resistant surfaces that are easy to maintain.

Des espaces en dialogue avec la nature.

Ultra Outdoor interprète la matière comme un élément architectural.

Inspirées de la pierre naturelle et des bétons contemporains, les surfaces deviennent partie intégrante du paysage : sols, revêtements muraux, escaliers, margelles de piscine et cheminements.

Chaque environnement est un projet d'équilibre entre design et fonctionnalité :

- **Terrasses et patios :** surfaces homogènes, élégantes et agréables à la marche.
- **Jardins et cheminements :** solutions posables sur herbe ou gravier pour des parcours naturels.
- **Piscines et spas :** revêtements antidérapants coordonnés aux bords de bassin.
- **Espaces publics et zones urbaines :** surfaces durables, résistantes et faciles à entretenir.

Räume im Dialog mit der Natur.

Ultra Outdoor versteht Material als architektonisches Gestaltungselement.

Von Naturstein und zeitgenössischem Beton inspirierte Oberflächen werden Teil der Landschaft: Bodenbeläge, Wandverkleidungen, Treppen, Poolränder und Gehwege. Jede Umgebung ist ein ausgewogenes Zusammenspiel von Design und Funktionalität:

- **Terrassen und Patios:** gleichmäßige, elegante und begehkomfortable Oberflächen.
- **Gärten und Wege:** Lösungen für die Verlegung auf Gras oder Kies für natürliche Wegeführungen.
- **Pools und Spas:** rutschhemmende Bodenbeläge, abgestimmt auf die Beckenränder.
- **Öffentliche Räume und urbane Bereiche:** langlebige, widerstandsfähige und pflegeleichte Oberflächen.



Design consapevole, produzione responsabile.

Antica Ceramica Rubiera adotta processi produttivi a basso impatto ambientale:

- 100 % riciclo delle acque di processo
- 100 % degli scarti crudi e cotti
- Riduzione costante delle emissioni e dei consumi energetici

La lunga durata del gres porcellanato riduce gli interventi di sostituzione e manutenzione, contribuendo a un consumo più sostenibile delle risorse.

Ultra Outdoor è una scelta estetica, tecnica ed etica.

Certifications



UPEC F+
EN ISO 9001:2015
EN ISO 14001:2015
EN ISO 50001:2018
EN ISO 45001:2018
UNI EN ISO 14021: 2016
ENVIRONMENTAL PRODUCT DECLARATION (EPD)

Conscious design, responsible production.

Antica Ceramica Rubiera adopts low environmental impact manufacturing processes:

- 100% recycling of process water
- 100% recovery of unfired and fired waste
- Continuous reduction of emissions and energy consumption.

The long-lasting durability of porcelain stoneware reduces replacement and maintenance needs, contributing to more sustainable resource use.

Ultra Outdoor is an aesthetic, technical and ethical choice.

Design responsable, production durable.

Antica Ceramica Rubiera adopte des processus de fabrication à faible impact environnemental :

- Recyclage à 100 % des eaux de process
- Récupération 100 % des déchets crus et cuits
- Réduction continue des émissions et de la consommation énergétique.

La grande durabilité du grès cérame limite les interventions de remplacement et de maintenance, contribuant à une utilisation plus durable des ressources.

Ultra Outdoor est un choix esthétique, technique et éthique.

Bewusstes Design, verantwortungsvolle Produktion.

Antica Ceramica Rubiera setzt auf Produktionsprozesse mit geringer Umweltbelastung:

- 100 % Recycling des Prozesswassers
- Vollständige Rückgewinnung von Roh- und Brennverlusten
- Kontinuierliche Reduzierung von Emissionen und Energieverbrauch.

La grande durabilité du grès cérame limite les interventions de remplacement et de maintenance, contribuant à une utilisation plus durable des ressources.

Ultra Outdoor est un choix esthétique, technique et éthique.

La forza della natura, l'eleganza del design.

Ultra Outdoor propone una palette di 77 colori, 12 superfici e 5 formati, disponibili in due spessori.

Dalle texture pietra alle interpretazioni cemento, dalle tonalità calde del travertino ai grigi urbani più moderni, ogni superficie è pensata per armonizzarsi con l'ambiente circostante.

La resa materica e la profondità cromatica garantiscono un effetto naturale e autentico, valorizzando ogni progetto di architettura contemporanea.

The strength of nature, the elegance of design.

Ultra Outdoor offers a palette of 77 colors, 12 surfaces and 5 formats, available in two thicknesses.

From stone textures to concrete interpretations, from the warm tones of travertine to the most modern urban greys, each surface is designed to blend harmoniously with its surroundings. The material depth and chromatic richness ensure a natural and authentic effect, enhancing every contemporary architectural project.

La force de la nature, l'élégance du design.

Ultra Outdoor propose une palette de 77 couleurs, 12 surfaces et 5 formats, disponibles en deux épaisseurs.

Des textures pierre aux interprétations béton, des tons chauds du travertin aux gris urbains les plus contemporains, chaque surface est conçue pour s'harmoniser avec l'environnement. La richesse matérielle et la profondeur chromatique garantissent un rendu naturel et authentique, valorisant chaque projet d'architecture contemporaine.

Die Kraft der Natur, die Eleganz des Designs.

Ultra Outdoor bietet eine Palette von 77 Farben, 12 Oberflächen und 5 Formaten, erhältlich in zwei Stärken.

Von Steinstrukturen über Betoninterpretationen bis hin zu den warmen Travertintönen und den modernsten urbanen Grautönen - jede Oberfläche ist darauf ausgelegt, sich harmonisch in die Umgebung einzufügen. Die materielle Wirkung und die farbliche Tiefe sorgen für einen natürlichen und authentischen Effekt und werten jedes zeitgenössische Architekturprojekt auf.

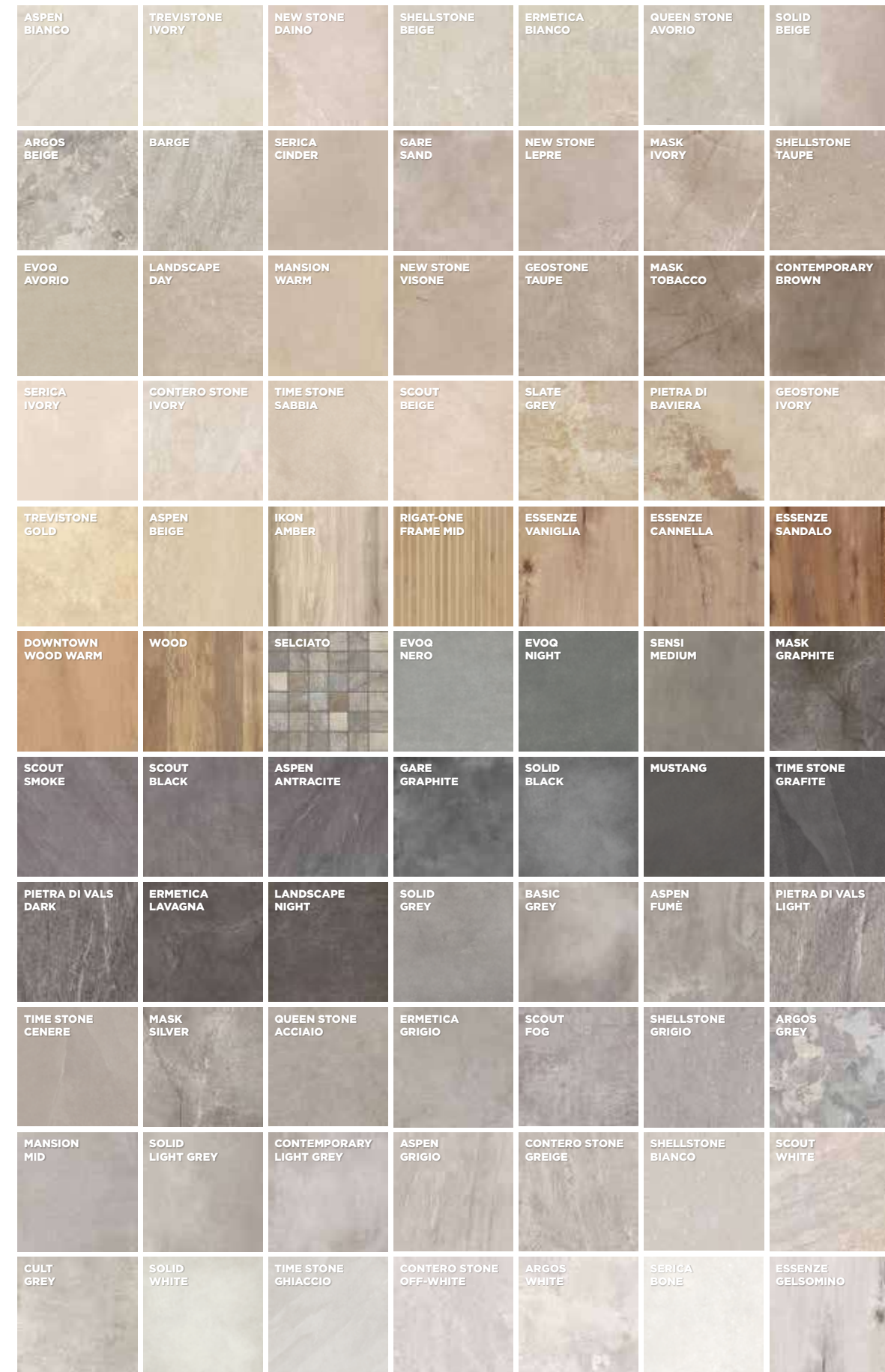

77
ultra
colors

54 Stone look
15 Concrete look
8 Wood look

5
sizes

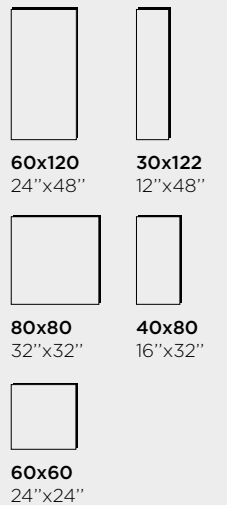

12
surface
structures

2
thick-
ness

≅ 20 mm 3/4"
≅ 30 mm 1 1/4"

collezioni effetto pietra

Collezioni Collections

- 25 Ultra Argos
- 17 Ultra Aspen
- 32 Ultra Barge
- 32 Ultra Baviera
- 22 Ultra Contero Stone
- 23 Ultra Ermetica
- 26 Ultra Geostone
- 28 Ultra Landscape
- 30 Ultra Mansion
- 18 Ultra Mask
- 33 Ultra Mustang
- 24 Ultra New Stone
- 31 Ultra Pietra di Vals
- 29 Ultra Queen Stone
- 16 Ultra Scout
- 33 Ultra Selciato
- 21 Ultra Serica
- 20 Ultra Shellstone
- 32 Ultra Slate
- 19 Ultra Time Stone
- 27 Ultra Trevistone

Formati Sizes

	≈ 2 cm 3/4"				≈ 3 cm 1/4"			
	60x120 24"x48"	80x80* 32"x32"	40x80* 16"x32"	60x60 24"x24"	80x80 32"x32"	40x80 16"x32"	60x60 24"x24"	
ULTRA ARGOS BEIGE								
ULTRA ARGOS GREY								
ULTRA ARGOS WHITE								
ULTRA ASPEN ANTRACITE	•	•	•				•	
ULTRA ASPEN BEIGE	•							
ULTRA ASPEN BIANCO								
ULTRA ASPEN FUMÉ								
ULTRA ASPEN GRIGIO	•	•	•				•	
ULTRA BARGE								
ULTRA BAVIERA								
ULTRA CONTERO STONE GREIGE	•					•		
ULTRA CONTERO STONE IVORY	•					•		
ULTRA CONTERO STONE OFF-WHITE	•					•		
ULTRA ERMETICA BIANCO						•		
ULTRA ERMETICA GRIGIO						•		
ULTRA ERMETICA LAVAGNA						•		
ULTRA GEOSTONE IVORY		•			•		•	
ULTRA GEOSTONE TAUPE		•			•		•	
ULTRA LANDSCAPE DAY								
ULTRA LANDSCAPE NIGHT								
ULTRA MANSION MID								
ULTRA MANSION WARM								
ULTRA MASK GRAPHITE							•	
ULTRA MASK IVORY							•	
ULTRA MASK SILVER							•	
ULTRA MASK TOBACCO							•	
ULTRA MUSTANG							•	
ULTRA NEW STONE DAINO								
ULTRA NEW STONE LEPRE	•							
ULTRA NEW STONE VISIONE	•							
ULTRA QUEENSTONE ACCIAIO	•							
ULTRA QUEENSTONE AVORIO	•							
ULTRA SCOUT BEIGE	•	•			•		•	
ULTRA SCOUT BLACK								
ULTRA SCOUT FOG		•						
ULTRA SCOUT SMOKE							•	
ULTRA SCOUT WHITE								
ULTRA SELCIATO								
ULTRA SERICA BONE	•					•	•	
ULTRA SERICA IVORY	•				•	•	•	
ULTRA SERICA CINDER	•				•	•	•	
ULTRA SHELLSTONE BEIGE	•							
ULTRA SHELLSTONE BIANCO	•							
ULTRA SHELLSTONE GRIGIO	•					•		
ULTRA SHELLSTONE TAUPE	•							
ULTRA SLATE GREY							•	
ULTRA TIME STONE CENERE	•				•		•	
ULTRA TIME STONE GHIACCIO	•				•		•	
ULTRA TIME STONE GRAFITE	•				•		•	
ULTRA TIME STONE SABBIA	•				•		•	
ULTRA TREVISTONE GOLD	•				•		•	
ULTRA TREVISTONE IVORY	•				•		•	
ULTRA VALS DARK	•							
ULTRA VALS LIGHT	•							

Scan to view product shade variation.



* Fino ad esaurimento scorte verrà fornito il formato 40,5x81 e 81x81. Subject to stock availability, sizes 40,5x81 and 81x81 will be supplied.



ULTRA SELCIATO 60X60



SHELLSTONE BEIGE & TAUPE 60X60



NEW STONE VISIONE 60X120



PIETRA DI BAVIERA 60X60



GEOSTONE TAUPE 60X60



PIETRA DI VALS LIGHT 60X60

ultra scout



Ultra Scout **FOG** V2

304366 80x80 cm 32"x32" ± 20mm 13 196
303571 60x60 cm 24"x24" ± 20mm 12 165



Ultra Scout **SMOKE** V2

303570 60x60 cm 24"x24" ± 20mm 18 165
303631 60x60 cm 24"x24" ± 30mm 18 202



Ultra Scout **BLACK** V2

303572 60x60 cm 24"x24" ± 20mm 6 165



Ultra Scout **WHITE** V2

303623 60x60 cm 24"x24" ± 20mm 18 165



Ultra Scout **BEIGE** V2

303803 60x120 cm 24"x48" ± 20mm 10 197
304329 80x80 cm 32"x32" ± 20mm 9 196
303569 60x60 cm 24"x24" ± 20mm 18 165
304476 80x80 cm 32"x32" ± 30mm 9 205
303632 60x60 cm 24"x24" ± 30mm 18 202

ultra aspen



Ultra Aspen **GRIGIO** V3

004547 60x120 cm 24"x48" ± 20mm 5 197
005838 80x80 cm 32"x32" ± 20mm 6 196
005841 40x80 cm 16"x32" ± 20mm 12 196
004154 60x60 cm 24"x24" ± 20mm 5 165
004195 60x60 cm 24"x24" ± 30mm 5 202



Ultra Aspen **FUMÉ** V3

004152 60x60 cm 24"x24" ± 20mm 6 165



Ultra Aspen **ANTHRACITE** V3

004548 60x120 cm 24"x48" ± 20mm 5 197
005837 80x80 cm 32"x32" ± 20mm 6 196
005842 40x80 cm 16"x32" ± 20mm 12 196
004153 60x60 cm 24"x24" ± 20mm 5 165
004194 60x60 cm 24"x24" ± 30mm 5 202



Ultra Aspen **BIANCO** V3

004151 60x60 cm 24"x24" ± 20mm 6 165



Ultra Aspen **BEIGE** V3

005616 60x120 cm 24"x48" ± 20mm 12 197
005055 60x60 cm 24"x24" ± 20mm 6 165



Certificazione disponibile per i seguenti articoli:
Collezione ASPEN 60x60 ± 20 mm in tutti i colori
Certification available for the following items:
ASPEN Collection 60x60 cm 24"x24" ± 20 mm in all colors

ultra mask



Ultra Mask
IVORY

V3

304027	60x60 cm	24"x24"	± 20mm	24	165
304083	60x60 cm	24"x24"	± 30mm	24	202

Ultra Mask
TOBACCO

V3

304024	60x60 cm	24"x24"	± 20mm	24	165
304080	60x60 cm	24"x24"	± 30mm	24	202



Ultra Mask
SILVER

V3

304025	60x60 cm	24"x24"	± 20mm	24	165
304081	60x60 cm	24"x24"	± 30mm	24	202

Ultra Mask
GRAPHITE

V3

304026	60x60 cm	24"x24"	± 20mm	24	165
304082	60x60 cm	24"x24"	± 30mm	24	202

ultra time stone



Ultra Time Stone
SABBIA

V3

TMS014	60x120 cm	24"x48"	± 20mm	12	197
TMS004	60x60 cm	24"x24"	± 20mm	24	165
TMS604	80x80 cm	32"x32"	± 30mm	10	205
TMS050	60x60 cm	24"x24"	± 30mm	24	202

Ultra Time Stone
CENERE

V3

TMS012	60x120 cm	24"x48"	± 20mm	12	197
TMS002	60x60 cm	24"x24"	± 20mm	24	165
TMS602	80x80 cm	32"x32"	± 30mm	10	205
TMS051	60x60 cm	24"x24"	± 30mm	24	202



Ultra Time Stone
GHIACCIO

V3

TMS001	60x60 cm	24"x24"	± 20mm	24	165
TMS511	60x60 cm	24"x24"	± 30mm	24	202

Ultra Time Stone
GRAFITE

V3

TMS013	60x120 cm	24"x48"	± 20mm	12	197
TMS003	60x60 cm	24"x24"	± 20mm	24	165
TMS603	80x80 cm	32"x32"	± 30mm	10	205
TMS513	60x60 cm	24"x24"	± 30mm	24	202



Certificazione disponibile per i seguenti articoli:
Collezione TIME STONE 60x60 ± 20 mm in tutti i colori
Certification available for the following items: TIME STONE
Collection 60x60 cm 24"x24" ± 20 mm in all colors

ultra shellstone



Ultra Shellstone
BIANCO



Ultra Shellstone
GRIGIO



- 005617 60x120 cm 24"x48" ± 20mm 8 197
- 005577 60x60 cm 24"x24" ± 20mm 16 165
- 005670 40x80 cm 16"x32" ± 30mm 10 203

- 005615 60x60 cm 24"x24" ± 20mm 16 165
- 005672 40x80 cm 16"x32" ± 30mm 10 203



Ultra Shellstone
BEIGE



Ultra Shellstone
TAUPE



- 006104 60x120 cm 24"x48" ± 20mm 8 197
- 005578 60x60 cm 24"x24" ± 20mm 16 165
- 005671 40x80 cm 16"x32" ± 30mm 10 203

- 005618 60x120 cm 24"x48" ± 20mm 8 197
- 005614 60x60 cm 24"x24" ± 20mm 16 165

ultra serica



Ultra Serica
BONE



Ultra Serica
CINDER



- 304302 60x120 cm 24"x48" ± 20mm 6 197
- 304299 60x60 cm 24"x24" ± 20mm 12 165
- 304308 40x80 cm 16"x32" ± 30mm 6 203
- 304305 60x60 cm 24"x24" ± 30mm 12 202

- 304304 60x120 cm 24"x48" ± 20mm 6 197
- 304301 60x60 cm 24"x24" ± 20mm 12 165
- 304325 80x80 cm 32"x32" ± 30mm 8 205
- 304310 40x80 cm 16"x32" ± 30mm 6 203
- 304307 60x60 cm 24"x24" ± 30mm 12 202

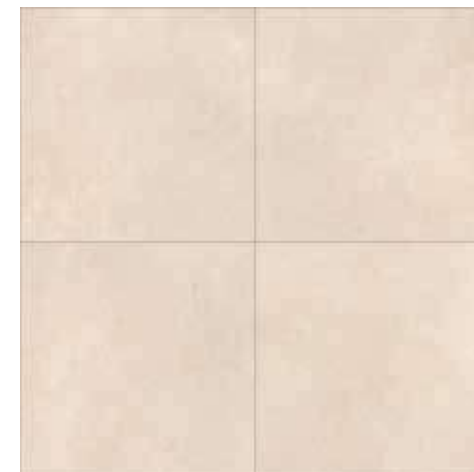

Ultra Serica
IVORY



- 304303 60x120 cm 24"x48" ± 20mm 6 197
- 304300 60x60 cm 24"x24" ± 20mm 12 165
- 304326 80x80 cm 32"x32" ± 30mm 8 205
- 304309 40x80 cm 16"x32" ± 30mm 6 203
- 304306 60x60 cm 24"x24" ± 30mm 12 202

ultra contero stone



Ultra Contero Stone
OFF-WHITE

005901	60x120 cm	24"x48"	± 20mm	12	197
005898	60x60 cm	24"x24"	± 20mm	24	165
005910	40x80 cm	16"x32"	± 30mm	18	203



Ultra Contero Stone
GREIGE

005902	60x120 cm	24"x48"	± 20mm	12	197
005899	60x60 cm	24"x24"	± 20mm	24	165
005911	40x80 cm	16"x32"	± 30mm	18	203



Ultra Contero Stone
IVORY

005903	60x120 cm	24"x48"	± 20mm	12	197
005900	60x60 cm	24"x24"	± 20mm	24	165
005912	40x80 cm	16"x32"	± 30mm	18	203

ultra ermetica



Ultra Ermetica
BIANCO

005426	60x60 cm	24"x24"	± 20mm	24	165
005667	40x80 cm	16"x32"	± 30mm	14	203



Ultra Ermetica
GRIGIO

005427	60x60 cm	24"x24"	± 20mm	24	165
005668	40x80 cm	16"x32"	± 30mm	14	203



Ultra Ermetica
LAVAGNA

005428	60x60 cm	24"x24"	± 20mm	24	165
005669	40x80 cm	16"x32"	± 30mm	14	203

ultra new stone



Ultra New Stone
DAINO
NWS321 60x60 cm 24"x24" ± 20mm 22 165



Ultra New Stone
VISIONE
NWS232 60x120 cm 24"x48" ± 20mm 11 197
NWS322 60x60 cm 24"x24" ± 20mm 22 165



Ultra New Stone
LEPRE
NWS233 60x120 cm 24"x48" ± 20mm 11 197
NWS323 60x60 cm 24"x24" ± 20mm 22 165

ultra argos



Ultra Argos
WHITE
304207 60x60 cm 24"x24" ± 20mm 24 165



Ultra Argos
GREY
304209 60x60 cm 24"x24" ± 20mm 24 165



Ultra Argos
BEIGE
304208 60x60 cm 24"x24" ± 20mm 24 165

ultra geostone

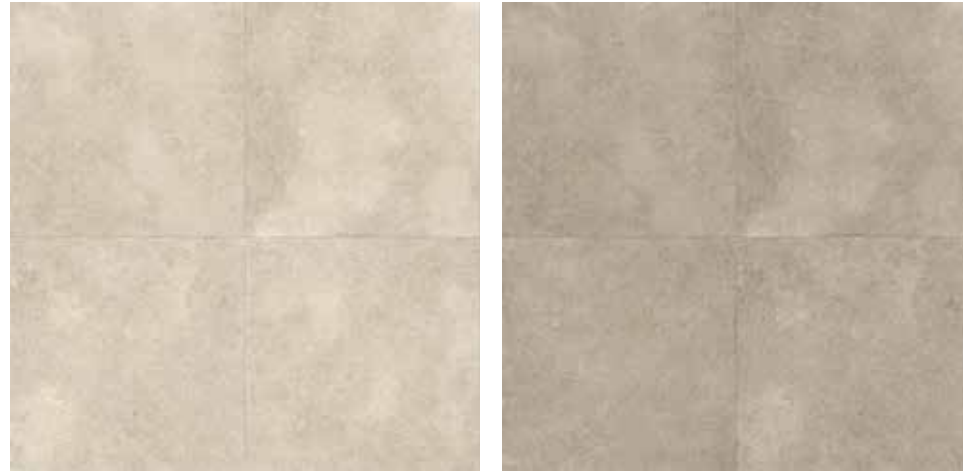

Ultra Geostone
IVORY



Ultra Geostone
TAUPE



304437	80x80 cm	32"x32"	≅ 20mm	8	196	304443	80x80 cm	32"x32"	≅ 20mm	8	197
304435	60x60 cm	24"x24"	≅ 20mm	24	165	304441	60x60 cm	24"x24"	≅ 20mm	24	165
304439	80x80 cm	32"x32"	≅ 30mm	8	205	304445	80x80 cm	32"x32"	≅ 30mm	8	205
304438	60x60 cm	24"x24"	≅ 30mm	24	202	304444	60x60 cm	24"x24"	≅ 30mm	24	202

ultra trevistone



Ultra Trevistone
IVORY



Ultra Trevistone
GOLD



304412	60x120 cm	24"x48"	≅ 20mm	7	197	005867	60x120 cm	24"x48"	≅ 20mm	7	197
304411	60x60 cm	24"x24"	≅ 20mm	14	165	005866	60x60 cm	24"x24"	≅ 20mm	14	165
304415	40x80 cm	16"x32"	≅ 30mm	14	203	005897	60x60 cm	24"x24"	≅ 30mm	14	202
304414	60x60 cm	24"x24"	≅ 30mm	14	202						

ultra landscape



Ultra Landscape
DAY
303626 60x60 cm 24"x24" ± 20mm 18 165

Ultra Landscape
NIGHT
303625 60x60 cm 24"x24" ± 20mm 19 165



ultra queen stone



Ultra Queen Stone
AVORIO
QST071 60x120 cm 24"x48" ± 20mm 9 197

Ultra Queen Stone
ACCIAIO
QST070 60x120 cm 24"x48" ± 20mm 9 197



ultra mansion

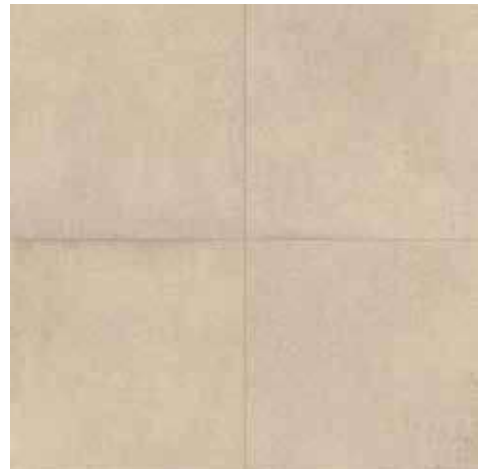

Ultra Mansion
WARM
303794 60x60 cm 24"x24" ± 20mm 24 165



Ultra Mansion
MID
303763 60x60 cm 24"x24" ± 20mm 24 165

ultra pietra di vals



Ultra Pietra Di Vals
LIGHT
304225 60x120 cm 24"x48" ± 20mm 7 197
303627 60x60 cm 24"x24" ± 20mm 14 165



Ultra Pietra Di Vals
DARK
303628 60x60 cm 24"x24" ± 20mm 14 165

ultra slate



Ultra Slate
GREY **V2**
 303620 60x60 cm 24"x24" ± 20mm 14 165
 303864 60x60 cm 24"x24" ± 30mm 14 202

ultra baviera



Ultra
BAVIERA **V4**
 303657 60x60 cm 24"x24" ± 20mm 20 165

ultra barge



Ultra
BARGE **V2**
 303621 60x60 cm 24"x24" ± 20mm 28 165

ultra mustang

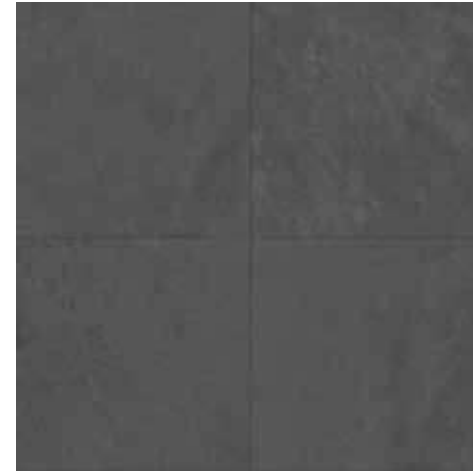

Ultra
MUSTANG **V2**
 303619 60x60 cm 24"x24" ± 20mm 23 165
 303636 60x60 cm 24"x24" ± 30mm 16 202

ultra selciato



Ultra
SELCIATO **V2**
 303768 60x60 cm 24"x24" ± 20mm 6 165

collezioni effetto cemento

Collezioni Collections

- 40 Ultra Basic
- 39 Ultra Contemporary
- 40 Ultra Cult
- 38 Ultra Evoq
- 37 Ultra Gare
- 40 Ultra Sensi
- 36 Ultra Solid

Formati Sizes

	≈ 2 cm 3/4"			≈ 3 cm 1 1/4"		
	60x120 24"x48"	80x80* 32"x32"	60x60 24"x24"	80x80 32"x32"	40x80 16"x32"	60x60 24"x24"
ULTRA BASIC GREY			•			•
ULTRA CONTEMPORARY BROWN			•			•
ULTRA CONTEMPORARY LIGHT GREY	•	•	•			•
ULTRA CONTERO STONE GREIGE	•		•		•	
ULTRA CULT GREY			•			
ULTRA EVOQ AVORIO			•			
ULTRA EVOQ NERO			•			
ULTRA EVOQ NIGHT			•			
ULTRA GARE GRAPHITE			•			•
ULTRA GARE SAND			•			•
ULTRA SENSI MEDIUM			•			•
ULTRA SOLID WHITE			•			•
ULTRA SOLID LIGHT GREY			•			•
ULTRA SOLID BLACK			•			•
ULTRA SOLID BEIGE			•	•	•	•
ULTRA SOLID GREY			•	•	•	•



EVOQ NIGHT 60X60



BASIC GREY 60X60



GARE SAND 60X60



CONTEMPORARY BROWN 60X60



EVOQ NERO 60X60



SOLID WHITE 60X60

Scan to view product shade variation.



* Fino ad esaurimento scorte verrà fornito il formato 81x81. Subject to stock availability, size 81x81 will be supplied.

ultra solid

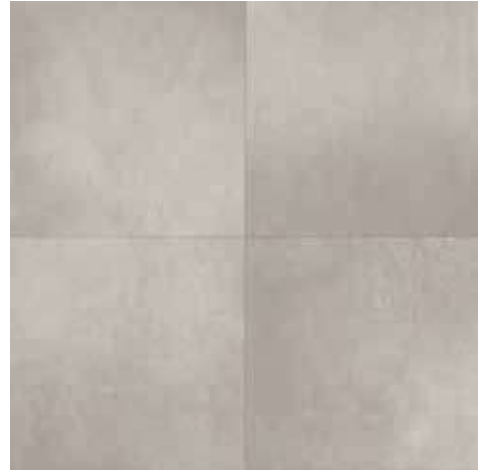

Ultra Solid
LIGHT GREY **V2**
303993 60x60 cm 24"x24" ± 20mm 24 165



Ultra Solid
GREY **V2**
304084 60x60 cm 24"x24" ± 30mm 24 202
304327 80x80 cm 32"x32" ± 30mm 12 205
304227 40x80 cm 16"x32" ± 30mm 9 203

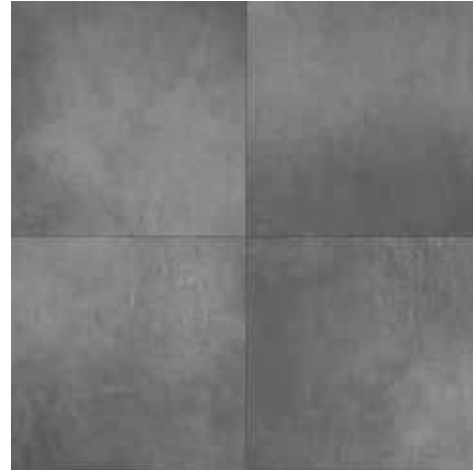

Ultra Solid
BLACK **V2**
303994 60x60 cm 24"x24" ± 20mm 24 165
304076 60x60 cm 24"x24" ± 30mm 24 202

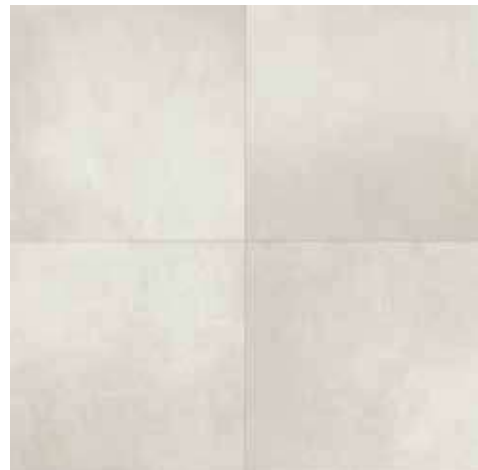

Ultra Solid
WHITE **V2**
303992 60x60 cm 24"x24" ± 20mm 24 165



Ultra Solid
BEIGE **V2**
303991 60x60 cm 24"x24" ± 20mm 24 165
304077 60x60 cm 24"x24" ± 30mm 24 202
304328 80x80 cm 32"x32" ± 30mm 12 205
304228 40x80 cm 16"x32" ± 30mm 9 203



Certificazione disponibile per i seguenti articoli:
Collezione SOLID 60x60 ± 20 mm nei seguenti colori:
White, Black, Light Grey
Certification available for the following items:
SOLID Collection 60x60 cm 24"x24" ± 20
in the following colors: White, Black, Light Grey

ultra gare



Ultra Gare
SAND **V3**
303607 60x60 cm 24"x24" ± 20mm 18 165
303609 60x60 cm 24"x24" ± 30mm 18 202



Ultra Gare
GRAPHITE **V3**
303606 60x60 cm 24"x24" ± 20mm 16 165
303608 60x60 cm 24"x24" ± 30mm 16 202



Certificazione disponibile per i seguenti articoli:
Collezione GARE DU NORD 60x60 ± 20 mm
in tutti i colori
Certification available for the following items:
GARE DU NORD Collection 60x60 cm 24"x24" ± 20 mm in all colors

ultra evoq



Ultra Evoq
NERO
005435 60x60 cm 24"x24" ± 20mm 8 165



Ultra Evoq
NIGHT
005436 60x60 cm 24"x24" ± 20mm 8 165



Ultra Evoq
AVORIO
005434 60x60 cm 24"x24" ± 20mm 8 165

ultra contemporary



Ultra Contemporary
LIGHT GREY
004549 60x120 cm 24"x48" ± 20mm 12 197
005885 80x80 cm 32"x32" ± 20mm 27 196
004133 60x60 cm 24"x24" ± 20mm 31 165
004135 60x60 cm 24"x24" ± 30mm 31 202



Ultra Contemporary
BROWN
004134 60x60 cm 24"x24" ± 20mm 26 165

ultra basic

ultra cult

ultra sensi



Ultra Basic
GREY
V2
303568 60x60 cm 24"x24" ± 20mm 36 165
303635 60x60 cm 24"x24" ± 30mm 19 202

Ultra Cult
GREY
V4
303624 60x60 cm 24"x24" ± 20mm 30 165

Ultra Sensi
MEDIUM
V2
303935 60x60 cm 24"x24" ± 30mm 7 202



ULTRA CULT GREY 60X60

collezioni effetto legno

Collezioni Collections

- 46 Ultra Downtown Wood
- 44 Ultra Essenze
- 45 Ultra Ikon
- 46 Ultra Rigat-One Frame
- 45 Ultra Wood

	≅ 2 cm 3/4"				≅ 3 cm 1/4"
	60x120 24"x48"	30x122 12"x48"	40x80* 16"x32"	60x60 24"x24"	40x80 16"x32"
ULTRA DOWNTOWN WOOD WARM					
ULTRA ESSENZE CANNELLA		•	•		•
ULTRA ESSENZE GELSOMINO			•		
ULTRA ESSENZE SANDALO			•		
ULTRA ESSENZE VANIGLIA			•		
ULTRA IKON AMBER		•			•
ULTRA RIGATONE FRAME MID	•				
ULTRA WOOD				•	



WOOD 60X60



DOWNTOWN WOOD WARM 30X122 & SPECIAL PIECES



DOWNTOWN WOOD WARM 30X122



RIGAT-ONE FRAME MID 60X120



ESSENZE CANNELLA 40X80



IKON AMBER 30X122

Scan to view product shade variation.



* Fino ad esaurimento scorte verrà fornito il formato 40,5x81. Subject to stock availability, size 40.5x81 will be supplied.

ultra essenze



Ultra Essenze
GELSOMINO
304374 40x80 cm 16"x32" ± 20mm 32 196



Ultra Essenze
VANIGLIA
304330 40x80 cm 16"x32" ± 20mm 32 196



Ultra Essenze
CANNELLA
303805 30x122 cm 12"x48" ± 20mm 10 198
304361 40x80 cm 16"x32" ± 20mm 32 196



Ultra Essenze
SANDALO
304362 40x80 cm 16"x32" ± 20mm 48 196

ultra ikon



Ultra Ikon
AMBER
303807 30x122 cm 12"x48" ± 20mm 10 198
304477 40x80 cm 16"x32" ± 30mm 12 203

ultra wood



Ultra
WOOD
303622 60x60 cm 24"x24" ± 20mm 20 165

ultra d.wood

ultra rigat-one



Ultra Downtown Wood

WARM

V2

Ultra Rigat-One

FRAME MID

V2

005624 30x122 cm 12"x48" ± 20mm 16 198
005673 40x80 cm 16"x32" ± 30mm 8 203

005628 60x120 cm 24"x48" ± 20mm 6 197



ULTRA ESSENZE CANNELLA 30X122

gamma completa ultra outdoor

Ultra Outdoor complete range . Gamme complète Ultra Outdoor . Komplettes Ultra Outdoor Sortiment

Gres porcellanato Rettificato Rectified Porcelain stoneware. Grès cérame rectifié. Feinsteinzeug Geschliffen einkalibrig	≅ 20 mm 3/4"				≅ 30 mm 1 1/4"			
	60x120 24"x48"	30x122 12"x48"	80x80* 32"x32"	40x80* 16"x32"	60x60 24"x24"	80x80 32"x32"	40x80 16"x32"	60x60 24"x24"
ULTRA ARGOS BEIGE								
ULTRA ARGOS GREY								
ULTRA ARGOS WHITE								
ULTRA ASPEN ANTRACITE	•		•	•				•
ULTRA ASPEN BEIGE	•							
ULTRA ASPEN BIANCO								
ULTRA ASPEN FUMÈ								
ULTRA ASPEN GRIGIO	•		•	•				•
ULTRA BARGE								
ULTRA BASIC GREY								•
ULTRA BAVIERA								
ULTRA CONTEMPORARY BROWN								
ULTRA CONTEMPORARY LIGHT GREY	•		•					•
ULTRA CONTERO STONE GREIGE	•						•	
ULTRA CONTERO STONE IVORY	•						•	
ULTRA CONTERO STONE OFF-WHITE	•						•	
ULTRA CULT GREY								
ULTRA DOWNTOWN WOOD WARM		•						
ULTRA ERMETICA BIANCO							•	
ULTRA ERMETICA GRIGIO							•	
ULTRA ERMETICA LAVAGNA							•	
ULTRA ESSENZE CANNELLA		•						
ULTRA ESSENZE GELSOMINO				•				
ULTRA ESSENZE SANDALO				•				
ULTRA ESSENZE VANIGLIA				•				
ULTRA EVOQ AVORIO					•			
ULTRA EVOQ NERO					•			
ULTRA EVOQ NIGHT					•			
ULTRA GARE GRAPHITE					•			•
ULTRA GARE SAND					•			•
ULTRA GEOSTONE IVORY			•		•		•	•
ULTRA GEOSTONE TAUPE			•		•		•	•
ULTRA IKON AMBER		•			•		•	
ULTRA LANDSCAPE DAY					•			
ULTRA LANDSCAPE NIGHT					•			
ULTRA MANSION MID					•			
ULTRA MANSION WARM					•			
ULTRA MASK GRAPHITE					•			•
ULTRA MASK IVORY					•			•
ULTRA MASK SILVER					•			•
ULTRA MASK TOBACCO					•			•
ULTRA MUSTANG					•			•
ULTRA NEW STONE DAINO					•			
ULTRA NEW STONE LEPRE	•				•			
ULTRA NEW STONE VISONE	•				•			
ULTRA QUEENSTONE ACCIAIO	•				•			
ULTRA QUEENSTONE AVORIO	•				•			
ULTRA RIGATONE FRAME MID	•				•			
ULTRA SCOUT BEIGE	•		•		•		•	•
ULTRA SCOUT BLACK					•			
ULTRA SCOUT FOG			•		•			
ULTRA SCOUT SMOKE					•			•
ULTRA SCOUT WHITE					•			
ULTRA SELCIATO					•			
ULTRA SENSI MEDIUM					•			•
ULTRA SERICA BONE	•				•		•	•
ULTRA SERICA IVORY	•				•		•	•
ULTRA SERICA CINDER	•				•		•	•
ULTRA SHELLSTONE BEIGE	•				•		•	•
ULTRA SHELLSTONE BIANCO	•				•		•	•
ULTRA SHELLSTONE GRIGIO	•				•		•	•
ULTRA SHELLSTONE TAUPE	•				•		•	•
ULTRA SLATE GREY					•			•
ULTRA SOLID WHITE					•			
ULTRA SOLID LIGHT GREY					•			
ULTRA SOLID BLACK					•			•
ULTRA SOLID BEIGE					•			•
ULTRA SOLID GREY					•	•	•	•
ULTRA TIME STONE CENERE	•				•			•
ULTRA TIME STONE GHIACCIO					•			•
ULTRA TIME STONE GRAFITE	•				•			•
ULTRA TIME STONE SABBIA	•				•			•
ULTRA TREVISTONE GOLD	•				•			•
ULTRA TREVISTONE IVORY	•				•			•
ULTRA VALS DARK					•	•		•
ULTRA VALS LIGHT	•				•			
ULTRA WOOD					•			



imballi

weight and sizes . poids et mesures . gewichte und verpackungen

dimensioni sizes dimensions abmessungen	spessore thickness épaisseur stärke	pz/collo pcs/box pc/boite stk/ktn	mq/collo sqm/box m/boite qm/ktn	kg/collo kg/box kg/boite kg/ktn	colli/pallet box/europal boites/europal ktn/europal	mq/pallet sqm/pallet m/pallet qm/pallet	kg/europal kg/europal kg/europal kg/europal
60x60 Rettificato	20 mm	2	0,72	31,60	30	21,60	975
80x80 Rettificato*	20 mm	2	1,28	57,00	24	30,72	1395
40x80 Rettificato*	20 mm	2	0,64	28,00	30	19,20	865
30x122 Rettificato	20 mm	2	0,732	31,65	36	26,352	1160
60x120 Rettificato	20 mm	1	0,72	32,50	30	21,60	995
60x60 Rettificato	30 mm	1	0,36	25,00	40	14,40	1025
80x80 Rettificato	30 mm	1	0,64	42,00	30	19,220	1260
40x80 Rettificato	30 mm	2	0,64	42,00	27	17,28	1160

* Fino ad esaurimento scorte verrà fornito il formato 40,5x81 e 81x81. Subject to stock availability, sizes 40.5x81 and 81x81 will be supplied.
Sous réserve de disponibilité, les formats 40,5x81 et 81x81 seront proposés. Vorbehaltlich der Verfügbarkeit werden die Formate 40,5x81 und 81x81 bereitgestellt.



Funzionalità e continuità estetica in ogni dettaglio.

I pezzi speciali Ultra Outdoor completano e arricchiscono il progetto, garantendo continuità visiva e coerenza materica in ogni applicazione. Gradoni, Elementi a L e Griglie vengono realizzati con la stessa materia e le stesse finiture delle lastre principali, assicurando un risultato estetico uniforme e professionale.

Questi elementi tecnici rappresentano la **connessione perfetta tra funzionalità e design**: ogni particolare diventa parte integrante dell'architettura, offrendo soluzioni pratiche e sicure per ogni tipo di spazio esterno.

Functionality and aesthetic continuity in every detail.

Ultra Outdoor special pieces complete and enhance the project, ensuring visual continuity and material consistency in every application. Steps, L-shaped elements and drainage grilles are produced using the same material and finishes as the main slabs, guaranteeing a uniform and professional aesthetic result. These technical elements represent the perfect connection between functionality and design: every detail becomes an integral part of the architecture, offering practical and safe solutions for all types of outdoor spaces.

Fonctionnalité et continuité esthétique dans chaque détail.

Les pièces spéciales Ultra Outdoor complètent et valorisent le projet, en garantissant une continuité visuelle et une cohérence de matière dans chaque application. Marches, éléments en L et grilles de drainage sont réalisés dans la même matière et avec les mêmes finitions que les dalles principales, assurant un rendu esthétique homogène et professionnel. Ces éléments techniques représentent le lien parfait entre fonctionnalité et design : chaque détail devient une partie intégrante de l'architecture, offrant des solutions pratiques et sûres pour tous les types d'espaces extérieurs.

Funktionalität und ästhetische Kontinuität bis ins Detail.

Die Spezialelemente von Ultra Outdoor vervollständigen und bereichern das Projekt und gewährleisten visuelle Kontinuität sowie materielle Einheitlichkeit in jeder Anwendung. Stufen, L-Elemente und Entwässerungsgroste werden aus demselben Material und mit denselben Oberflächen wie die Hauptplatten gefertigt und sorgen so für ein einheitliches und professionelles Erscheinungsbild. Diese technischen Elemente stellen die perfekte Verbindung zwischen Funktionalität und Design dar: Jedes Detail wird zum integralen Bestandteil der Architektur und bietet praktische und sichere Lösungen für alle Arten von Außenbereichen.

gradone monolitico



Gradone Arrotondato

Rounded Coping
Nez de marche arrondi
Monolitische Stufenplatten

30x60 cm 12"x24"	± 20mm	141	■
40x80 cm 16"x32"	± 20mm	194	■
30x120 cm 12"x48"	± 20mm	171	■
30x122 cm 12"x48"	± 20mm	171	■



Gradone Arrotondato con gocciolatoio

Rounded coping with drip
Nez de marche arrondi avec goutte d'eau
Monolitische Stufenplatten mit Abtropfen

30x60 cm 12"x24"	± 20mm	190	■
40x80 cm 16"x32"	± 20mm	198	■
30x120 cm 12"x48"	± 20mm	236	■
30x122 cm 12"x48"	± 20mm	236	■

Esterno
Outside
Extérieur
Außen



Interno
Inside
Intérieur
Innen



Angolari destro e sinistro disponibili nel formato 30x60. Right and left corner pieces available in 30x60 format
Angles droit et gauche disponibles au format 30x60. Gitterecke Rechte und linke Eckelemente im Format 30x60 verfügbar

30x60 cm 12"x24" ± 20mm

208 ■

Altri pezzi speciali disponibili su richiesta Other special pieces available on demand for swimming pool
Pièces Spéciales Supplémentaires Sur Demande - Weitere Spezielle auf Anfrage

gradone monolitico



Gradone arrotondato con scanalature

Rounded coping with grooves
Nez de marche arrondi avec rainures
Monolitische Stufenplatten mit Rillen

30x60 cm 12"x24"	± 20mm	190	■
40x80 cm 16"x32"	± 20mm	198	■
30x120 cm 12"x48"	± 20mm	236	■
30x122 cm 12"x48"	± 20mm	236	■



Gradone arrotondato con gocciolatoio e scanalature

Rounded coping with drip and grooves
Nez de marche arrondi avec rainures et goutte d'eau
Monolitische Stufenplatten mit Abtropfen und Rillen

30x60 cm 12"x24"	± 20mm	233	■
40x80 cm 16"x32"	± 20mm	74	■
30x120 cm 12"x48"	± 20mm	239	■
30x122 cm 12"x48"	± 20mm	239	■

Altri pezzi speciali disponibili su richiesta Other special pieces available on demand for swimming pool
Pièces Spéciales Supplémentaires Sur Demande - Weitere Spezielle auf Anfrage

gradone a L



Gradone a L

L Coping
Nez de marche L
Stufenplatten "L"

30x60 cm 12"x24"	≈ 20/50mm	200
40x80 cm 16"x32"	≈ 20/50mm	235
30x120 cm 12"x48"	≈ 20/50mm	215
30x122 cm 12"x48"	≈ 20/50mm	215

gradoni in Klinker estruso



Gradone Domus Bordo arrotondato *

Rounded edge Coping Domus
Nez de marche Domus avec Bord arrondi
Stufenplatten Domus mit Abgerundet

005624 Aspen Grigio	34x124 cm 13.3"x48.8"	≈ 20mm	1
006065 Aspen Beige	34x62 cm 13.3"x24.4"	≈ 20mm	1
006064 Aspen Grigio	34x124 cm 13.3"x48.8"	≈ 20mm	1
006066 Aspen Beige	34x62 cm 13.3"x24.4"	≈ 20mm	1

* **Disponibili solo su ordinazione** Available on demand
Disponibili su richiesta anche nello spessore 1 cm
Also available on request in 1 cm thickness.

ideale per scale e bordi piscina. Possibilità di colori personalizzati su richiesta su lotto minimo di 500 pezzi.

Ideal for stairs and pool edges. Custom colors available upon request, with a minimum order of 500 pieces per batch.
Idéal pour les escaliers et les bords de piscine. Possibilité de couleurs personnalisées sur demande, avec un lot minimum de 500 pièces.
Ideal für Treppen und Poolränder. Kundenspezifische Farben auf Anfrage möglich, bei einer Mindestbestellmenge von 500 Stück.

Altri pezzi speciali disponibili su richiesta Other special pieces available on demand for swimming pool
Pièces Spéciales Supplémentaires Sur Demande - Weitere Spezielle auf Anfrage

griglie



Griglie

Grids
Grid
Gitter

14,5x40,5 cm 6"x16"	≈ 20mm	196
19,5x40,5 cm 8"x16"	≈ 20mm	196
14,5x60 cm 6"x24"	≈ 20mm	233
19,5x60 cm 8"x24"	≈ 20mm	170
19,5x40,5 cm 8"x16"	≈ 30mm	81
14,5x60 cm 6"x24"	≈ 30mm	234
19,5x60 cm 8"x24"	≈ 30mm	200

• **Non disponibili per gli articoli:** Not available for the items:
Essenze Gelsomino, Essenze Vaniglia, Essenze Sandalo,



Angoli Griglie disponibili su ordinazione

Grids Corner available on demand
Angle Grid disponible en option
Gitterecke Auf Bestellung

Altri pezzi speciali disponibili su richiesta Other special pieces available on demand for swimming pool
Pièces Spéciales Supplémentaires Sur Demande - Weitere Spezielle auf Anfrage

griglie snodate



Griglie Snodate

Flexible Grids
Grilles Articulées
Gelenkroste

25x50 cm 10"x20"	* ≈ 20mm	174
-------------------------	----------	-----

Si può scegliere una larghezza da 14cm a 25cm, lunghezza fissa da 50cm, il prezzo è inteso al pezzo e non cambia in base alla larghezza scelta. Made on demand, you can choose a width from 14 cm to 25 cm, with a fixed length of 50 cm. The price is per piece and does not change based on the chosen width.



* **La carrabilità e la portata delle nostre griglie dipendono dalla resistenza e dalle caratteristiche dei supporti utilizzati sotto di esse.**
The drive-over capability and load capacity of our grates depend on the strength and characteristics of the supports used beneath them.
La résistance à forts passages, roulage et la capacité de charge de nos grilles dépendent de la résistance et des caractéristiques des supports utilisés au-dessous.
Die Befahrbarkeit und Tragfähigkeit unserer Gitterroste hängen von der Festigkeit und den Eigenschaften der darunter verwendeten Träger ab.

Posa su erba - Installation on grass
Pose sur herbe - Verlegung auf Gras



Posa su ghiaia/sabbia - Installation on gravel/sand
Pose sur graviers/sable - Verlegung auf Kies/Sand



Posa su massetto con colla - Laying on screed with adhesive
Pose sur fond avec colle - Verlegung auf Estrich mit Kleber



Posa sopraelevata - Installation onto flat surfaces (raised laying)
Pose surélevée - Verlegung als Doppelboden



INSTALLATION SYSTEMS

Un'unica collezione, infinite possibilità di installazione.

Ultra Outdoor offre la massima libertà progettuale grazie a quattro sistemi di posa:

- Su erba: per giardini, parchi e zone verdi.
- Su sabbia o ghiaia: per vialetti e aree relax.
- Su massetto con colla: per superfici stabili e permanenti.
- Sopraelevata: per terrazze, camminamenti tecnici e pavimenti ispezionabili.
- Pareti ventilate: ideale per progetti residenziali e commerciali

Tutte le lastre sono rettificate e monocalibro, per una posa precisa e una perfetta modularità dei formati. Ogni progetto diventa personalizzabile, flessibile, reversibile.

One collection, endless installation possibilities.

Ultra Outdoor provides maximum design freedom through four installation systems:

- **On grass:** ideal for gardens, parks and green areas.
- **On sand or gravel:** for pathways and relaxation zones.
- **On mortar with adhesive:** for stable and permanent surfaces.
- **Raised:** for terraces, technical walkways and accessible flooring.
- **Ventilated Façades:** is the ideal choice for residential and commercial projects. All slabs are rectified and single-caliber, ensuring precise installation and perfect modularity of formats. Every project becomes customizable, flexible and reversible.

Une seule collection, des possibilités d'installation infinies.

Ultra Outdoor offre une liberté maximale de conception grâce à quatre systèmes de pose :

- **Sur gazon :** idéal pour jardins, parcs et espaces verts.
- **Sur sable ou gravier :** pour chemins et zones de détente.
- **Sur chape avec colle :** pour des surfaces stables et permanentes.
- **Surélevée :** pour terrasses, cheminements techniques et sols accessibles.
- **façades ventilées:** le choix idéal pour les projets résidentiels et commerciaux. Toutes les dalles sont rectifiées et monocalibres, assurant une pose précise et une modularité parfaite des formats. Chaque projet devient ainsi personnalisable, flexible et réversible.

Eine einzige Kollektion, unendliche Verlegungsmöglichkeiten.

Ultra Outdoor bietet maximale Planungsfreiheit dank vier Verlegesystemen:

- **Auf Rasen:** ideal für Gärten, Parks und Grünflächen.
- **Auf Sand oder Kies:** für Wege und Erholungsbereiche.
- **Auf Estrich mit Kleber:** für stabile und permanente Oberflächen.
- **Höhenverlegt:** für Terrassen, technische Laufwege und begehbare Böden.
- **Hinterlüftete Fassaden:** ist die ideale Wahl für Wohn- und Gewerbeprojekte. Alle Platten sind rektifiziert und einheitlich kalibriert, für eine präzise Verlegung und perfekte Modularität der Formate. Jedes Projekt wird so individualisierbar, flexibel und reversibel.



Posa su erba

Installation on grass

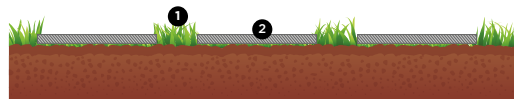

Posa diretta su erba

Direct installation on grass (Not suitable for lawn-mowers usage)

M Manto erboso • Grass surface

2 Lastra • Slab

Per ottenere un effetto "tappeto":
posizionare un cordolo in cemento
per delimitare l'area da piastrellare.
Realization of "carpet effect" flooring:
a cement curb can be laid to delimit
the area in which slabs are installed.

A Cordolo in cemento • Cement curb

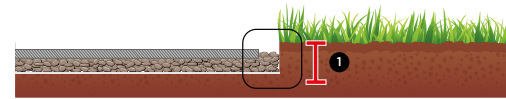
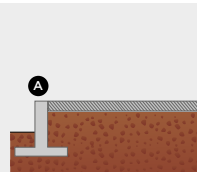

Posa a secco su erba

Installation on grass (Suitable for lawn-mowers usage)

1 5/6 cm di profondità • 5/6 cm dragging

2 Lastra posizionata più in basso del
manto erboso calpestabile • Slab to
be laid below grass level

3 Letto di ghiaia di almeno 3 cm di
profondità (granulometria > 4 mm)
Layer of gravel, minimum 3 cm
recommended (granulometry > 4mm)

4 Eventuale TNT • Macro-holed,
non-woven polypropylene fabric

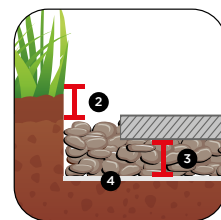

Distanza tra le lastre: posizionare le lastre distanziate tra loro in base all'effetto estetico che si vuole ottenere (camminamento "a passi", vialetto ecc). Distance between the slabs: slabs can be install to obtain several aesthetics effects/designs (walkway, stepping stone pattern and so on). Distance between slabs depends on the design we want to create.

Queste indicazioni rappresentano delle indicazioni generali basate sullo stato dell'arte e non vincolanti.
The following tips and suggestions are not binding for the manufacturer.



Posa su sabbia

Installation on sand

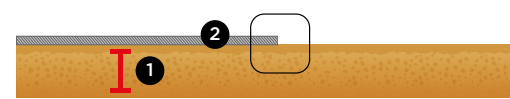

1 Strato di sabbia ben livellato 5/10 cm
Layer of sand duly leveled 5/10 cm

2 Lastra • Slab

Pendenza sottofondo 2%
Creation of 2% inclination
during levelling and
compacting phases.

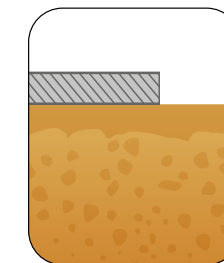

Distanza tra le lastre: posizionare le lastre distanziate tra loro in base all'effetto estetico che si vuole ottenere (camminamento "a passi", vialetto ecc). Le fughe possono essere riempite con sabbia o ghiaia. Distance between the slabs: slabs can be install to obtain several aesthetics effects/designs (walkway, stepping stone pattern and so on). Joints can be filled with sand or gravel.

Queste indicazioni rappresentano delle indicazioni generali basate sullo stato dell'arte e non vincolanti.
The following tips and suggestions are not binding for the manufacturer.

Posa su ghiaia

Installation on gravel

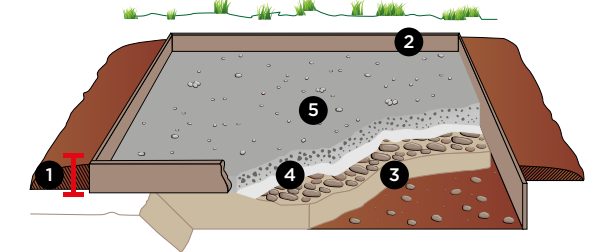
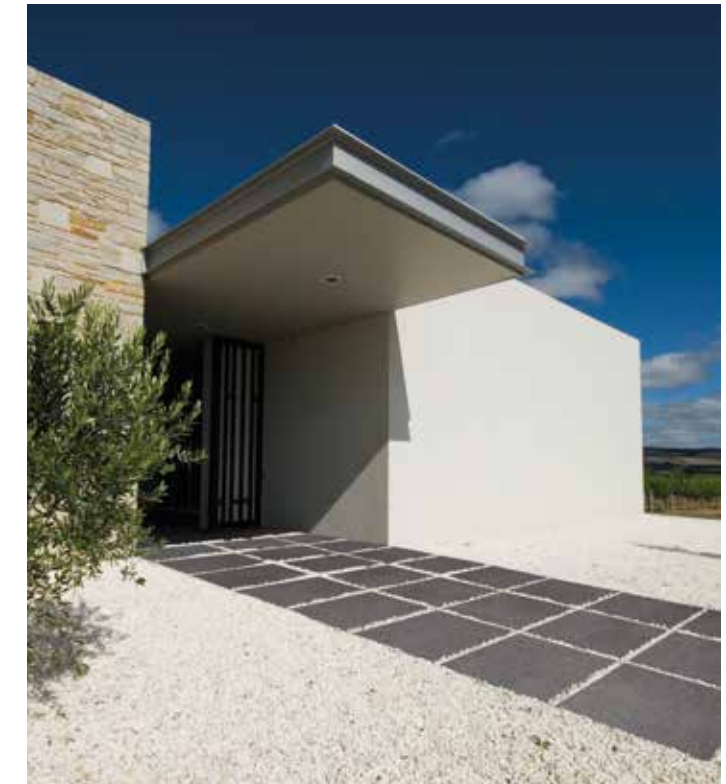

1 Asportare uno strato di terreno di 10-20 cm di profondità
Drag a layer of ground (10-20 cm)

2 Cordolo in cemento o assi di legno •
Cement curb or wooden plank

3 Pietrisco compatto granulometria mista (16-35 mm) per 10 cm
di profondità • Crushed stone, mixed granulometry (16-35 mm),
10 cm depth

4 TNT • Macro-holed, non-woven polypropylene fabric

5 Ghiaia ben livellata granulometria 4-8 mm per 10 cm di profondità
Duly leveled gravel, granulometry between 4-8 mm, 10 cm depth



Posa su massetto con colla

Laying on screed with adhesive



Posa su pavimento esterno non impermeabilizzato (terreno)

Installation on outdoor non waterproof floor (ground)

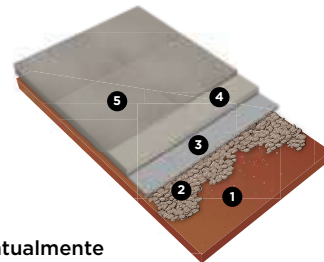

- 1 **Terreno** • Ground
- 2 **Strato di ghiaia compatto eventualmente stabilizzato con calcestruzzo** • Compact layer of gravel (eventually stabilized using concrete)
- 3 **Strato di livellamento in calcestruzzo avente spessore adeguato. Pendenza 1,25-2,5%** • Concrete leveling layer with adequate thickness. Inclination 1,25-2,5%
- 4 **Massetto di 8-10 cm con rete elettrosaldata posizionata a metà dello spessore dello strato** • 8-10 cm screed, arc welded mesh to be positioned in the centre
- 5 **Lastra** • Slab
Posa delle lastre con un collante per esterni seguendo sempre le indicazioni specifiche del produttore dell'adesivo utilizzato e seguendo la tecnica della doppia spalmatura • Slabs must be fixed by using an adhesive suitable for outdoor use and strictly following the instructions and specifications indicated by the adhesive's manufacturer (a double adhesive layer is always recommended)

Posa su pavimento esterno impermeabilizzato

Installation on outdoor waterproof floor

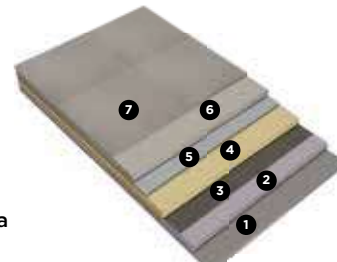

- 1 **Struttura portante (solaio)**
Floor
- 2 **Strato di livellamento/pendenza**
Levelling/inclination layer
- 3 **Strato di impermeabilizzazione**
Waterproofing layer
- 4 **Strato di separazione termoisolante**
Heat insulating layer
- 5 **Strato drenante** • Draining layer
- 6 **Massetto di 8-10 cm con rete elettrosaldata posizionata a metà dello spessore dello strato** • 8-10 cm screed, arc welded mesh to be positioned in the centre
- 7 **Lastra** • Slab
Posa delle lastre con un collante per esterni seguendo sempre le indicazioni specifiche del produttore dell'adesivo utilizzato e seguendo la tecnica della doppia spalmatura • Slabs must be fixed by using an adhesive suitable for outdoor use and strictly following the instructions and specifications indicated by the adhesive's manufacturer (a double adhesive layer is always recommended)

Fughe: obbligatoria la fuga a giunto aperto con ampiezza di fuga variabile maggiore di 5 mm ed utilizzo di sigillanti cementizi di classe 2. I giunti di dilatazione sono obbligatori.

Grout: using class 2 cement grouting and a minimum 5 mm grout line is mandatory. Expansion joints are mandatory too.

Queste indicazioni rappresentano delle indicazioni generali basate sullo stato dell'arte e non vincolanti. The following tips and suggestions are not binding for the manufacturer.



Posa sopraelevataa

Installation onto flat surfaces (raised laying)

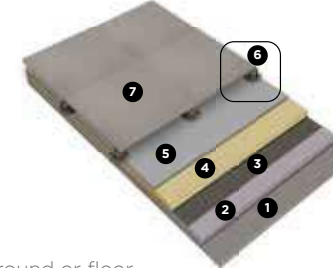

- 1 **Terreno o struttura portante** • Ground or floor
- 2 **Massetto in pendenza** • Screed with adequate inclination
- 3 **Strato di impermeabilizzazione** • Waterproofing layer
- 4 **Strato di separazione termoisolante (foglio di polietilene)**
Heat insulating layer (polyethylene sheet)
- 5 **Opzionale: pannello termoisolante di adeguata densità**
Optional: heat insulating panel with adequate density
- 6 **Supporto da esterno in polipropilene (fisso, regolabile o autolivellante)** • Polypropylene load-bearing supports suitable for outdoor (may be fixed, adjustable or self-levelling)
- 7 **OUTDOOR spessore • 20 • 30 mm**
OUTDOOR 20 • 30 mm thick slabs

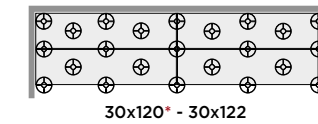
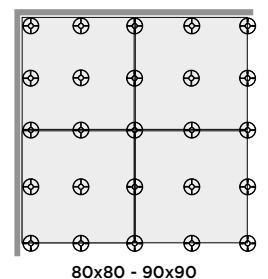
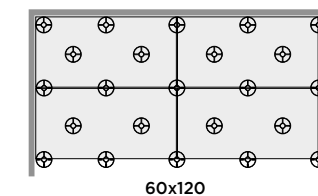
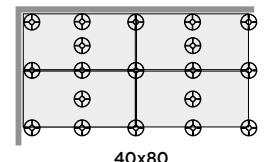
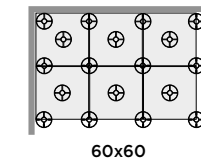

* pezzi speciali / special pieces

Ad oggi non esiste una normativa specifica per i pavimenti sopraelevati da esterno, si rimanda pertanto al professionista progettista un'attenta valutazione dei requisiti del progetto. Antica Ceramica Rubiera suggerisce l'utilizzo di supporti aggiuntivi sotto le piastrelle, come da schema sotto riportato. Per maggiore sicurezza e a tutela dell'utente, Antica Ceramica Rubiera richiede di impostare un'altezza di sopraelevazione non superiore a 5 cm. Per altezze superiori consultare il progettista. // To date there is no specific regulation for outdoor raised floors, therefore a careful evaluation of the project requirements is referred to the professional designer. Antica Ceramica Rubiera suggests the use of additional supports under the tiles, as per the diagram below. For major safety and user protection, Antica Ceramica Rubiera requires you to set a superlevation height no higher than 5 cm. For higher heights consult the project manager.

Queste indicazioni rappresentano delle indicazioni generali basate sullo stato dell'arte e non vincolanti. The following tips and suggestions are not binding for the manufacturer.



Pavimentazione carrabile

Installation on driveways

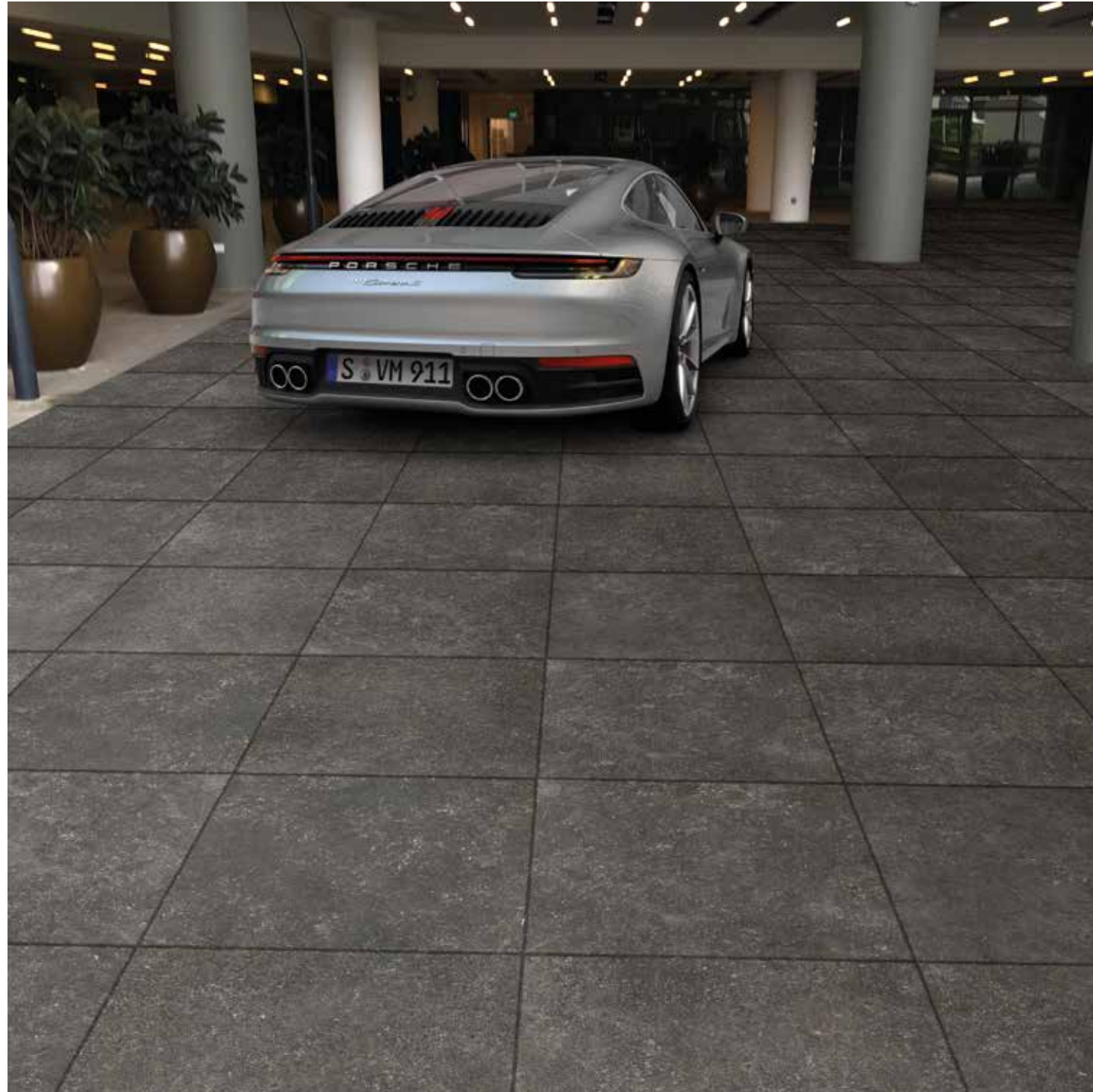

L'impiego di lastre con spessore 30 mm permette la realizzazione di pavimentazioni carrabili senza l'utilizzo di collanti per la posa.
30 mm porcelain pavers could be installed on driveways with no need of adhesives.

Queste indicazioni rappresentano delle indicazioni generali basate sullo stato dell'arte e non vincolanti.
The following tips and suggestions are not binding for the manufacturer.



Pareti ventilate

Ventilated walls

SISTEMA DI MONTAGGIO A SCOMPARSA PER FACCIATE VENTILATE.

Il nostro sistema di facciata ventilata è stato specificamente progettato per esaltare le qualità del gres porcellanato di grande formato 60x120 cm con spessore maggiorato di ≈ 20 mm. Offre una soluzione tecnologicamente avanzata che garantisce al contempo massima sicurezza strutturale e totale pulizia estetica grazie all'ancoraggio a scomparsa. Questo sistema è la scelta ideale per progetti residenziali e commerciali che richiedono un'estetica superiore abbinata a prestazioni di isolamento termico e durabilità eccezionali.
Progetti su misura, realizzati grazie al nostro supporto tecnico dedicato.

Concealed Mounting System for Ventilated Façades.

Our ventilated façade system has been specifically designed to enhance the qualities of large-format porcelain stoneware 60x120 cm with an increased thickness of 20 mm. It offers a technologically advanced solution that guarantees maximum structural safety and complete aesthetic cleanliness thanks to its concealed anchoring system.

This solution is the ideal choice for residential and commercial projects requiring premium aesthetics combined with exceptional thermal insulation performance and outstanding durability.

Custom-made projects developed with the support of our dedicated technical team.

Dettaglio intaglio piastrella

Focus details

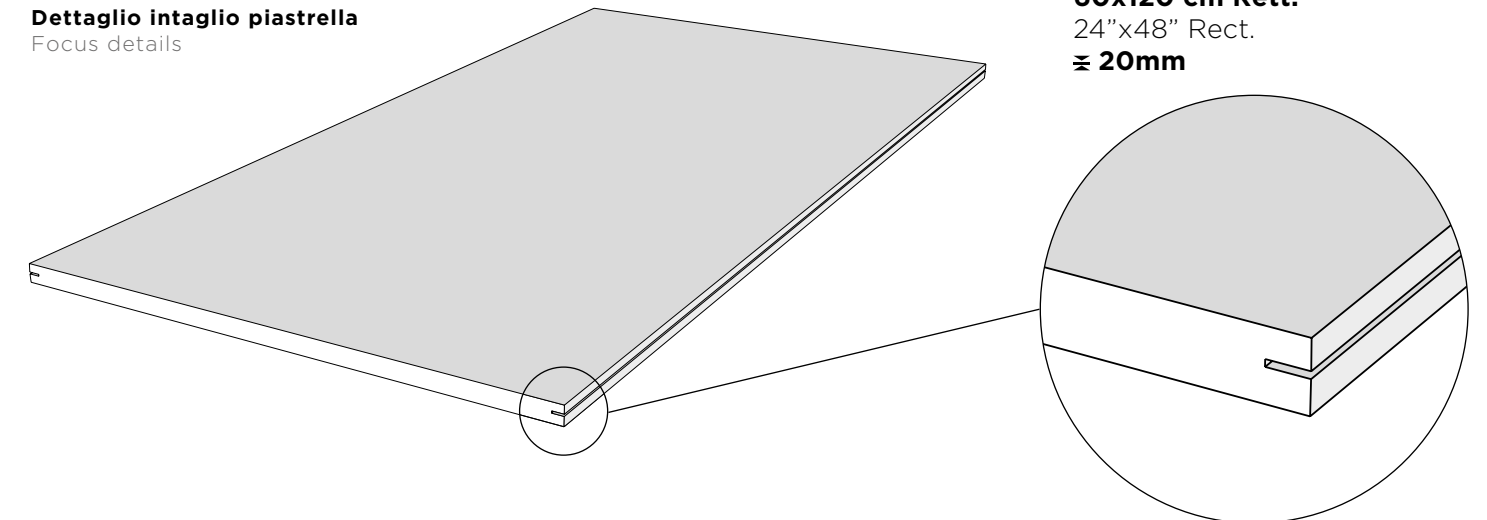

60x120 cm Rett.
24"x48" Rect.
 ≈ 20 mm

Sezione orizzontale

Horizontal section

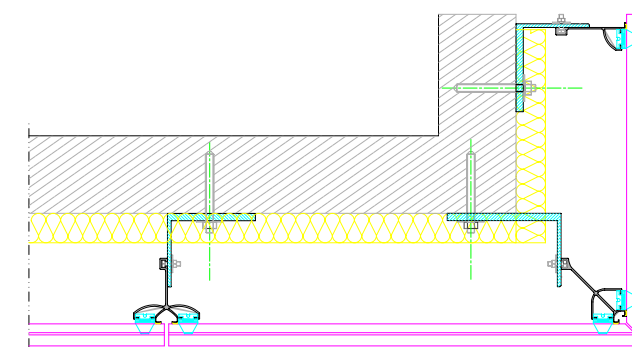

Sezione verticale

Vertical section

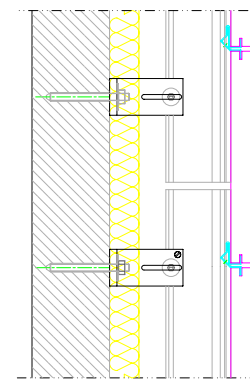

Tolleranze intaglio

carving tolerances

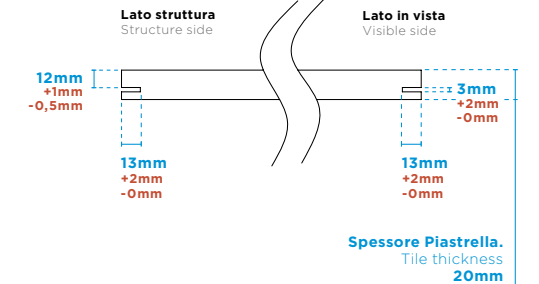

È richiesto un lotto minimo di produzione. Per maggiori dettagli si prega di consultare l'agente o il funzionario di zona.



Minimum quantities required. For more details please check with your sales representative. / Lot minimum de production impérative.

Queste indicazioni rappresentano delle indicazioni generali basate sullo stato dell'arte e non vincolanti.

The following tips and suggestions are not binding for the manufacturer.

TECHNICAL FEATURES

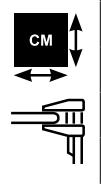
Gres porcellanato • Porcelain stoneware • Grès cérame • Feinsteinzeug **UNI EN 14411 Bla Allegato G (ISO 13006)**

Caratteristica tecnica Technical feature Caractéristique technique Technische Eigenschaft	Norma Norm Norme Norm	Valore richiesto dalle norme Required standards Valeur prescrite par les normes Normvorgabe	Ultra Outdoor			
 Lunghezza e larghezza / Lenght and width Longuer et largeur / Länge und breite Spessore / Thickness Epaisseur / Stärke Rettilineità spigoli / Straightness of sides Rectitude des aretes / Kantengeradheit Ortogonalità / Rectangularity Orthogonalite / Rechtwinkligkeit Planarità / Surface flatness Planeite de surface / Ebenflächigkeit	UNI EN ISO 10545-2	N ≥ 15 cm		Conforme Corresponding Conforme Entsprechend		
		%	(mm)			
		± 0,6 Non Rect. ± 0,3 Rect	± 2,0 Non Rect. ± 1,0 Rect			
		± 5	± 0,5			
Qualità della superficie Surface quality Qualités de la surface Oberflächenqualität	UNI EN ISO 10545-2	Il 95 % min. delle piastrelle di prova deve essere esente da difetti visibili Minimum 95% of the tested tiles must be free from visible defects 95% min. des carreaux de test ne doit pas contenir de défauts visibles Min. 95% der geprüften Fliesen dürfen keine sichtbaren Mängel aufweisen		Conforme Corresponding Conforme Entsprechend		
		≤ 0,5% Individual max 0,6%			≤ 0,5%	
		S ≥ 1300 N				S ≥ 1300 N
		R ≥ 35 N/mm²				
Resistenza ai prodotti chimici Resistance to chemical products Résistance aux produits chimiques Widerstand gegen Chemikalien	UNI EN ISO 10545-13	Resistenza a basse concentrazioni di acidi e alcali Resistance to low concentrations of acids and alkalis Secondo la classificazione indicata dal fabbricante Manufacturer is to state classification		LA		
		Resistenza ad alte concentrazioni di acidi e alcali Resistance to high concentrations of acids and alkalis Metodo di prova disponibile Test method available		HA		
		Resistenza ai prodotti chimici di uso domestico ed agli additivi per piscina Resistance to household chemicals and swimming pool salt Classe minima B Minimum class B		A		
Resistenza all'abrasione (metodo PEI) Abrasion resistance (PEI test) Résistance à l'abrasion (méthode PEI) Widerstand gegen Abrieb (nach PEI)	UNI EN ISO 10545-7	Segnala la classe di abrasione e i cicli superati Report abrasion class and cycles passed		disponibili sul sito internet alla sezione download della serie references available on the website in the download section of the series		
Resistenza alle macchie Staining resistance Resistance aux taches Widerstand gegen Fleckenbildung	UNI EN ISO 10545-14	Min. 3		Conforme Corresponding Conforme Entsprechend		
Resistenza agli sbalzi termici Thermal shock resistance Resistance aux écarts de température Temperaturwechselständigkeit	UNI EN ISO 10545-9	Metodo di prova disponibile Test method available		Resiste Resistant Résiste Widerstandsfähig		
Caratteristiche accessorie / Additional features						
Stabilità dei colori Colours stability Stabilité des couleurs Farbbeständigkeit	DIN 51094	Colorazione Stabile Stable coloring		Conforme Corresponding Conforme Entsprechend		
Caratteristiche di sicurezza / Safety characteristics						
 Resistenza allo scivolamento Slip resistance Résistance au glissement Rutschemmende Eigenchaft	METODO B.C.R.A.	μ > 0,40		Conforme Corresponding Conforme Entsprechend		
	DIN EN 16165	ANNEX A Test della rampa a piedi nudi / Classe dichiarata Barefoot ramp test / Declared Class Méthode de la rampe pieds nus / Classe déclarée Methode der schiefen Ebene, barfuß / Angegebene Klasse			R11	
		ANNEX B Test della rampa a piedi calzati / Classe dichiarata Shod ramp test / Declared Class Rampe avec chaussures / Classe déclarée Methode der schiefe Ebene, mit Schuhwerk / Angegebene Klasse				
DCOF (ANSI A 326.3)	≥ 0,42		Conforme Corresponding Conforme Entsprechend			

* La scheda tecnica dettagliata di ogni serie è disponibile sul sito sito aziendale . Technical data sheet of each collection is available for download on website
La fiche technique de chaque collection est disponible en téléchargement sur le site. Das technische Datenblatt jeder Kollektion steht auf der Website zum Download bereit.

Antica Ceramica Rubiera Catalogo Ultra Outdoor Febbraio 2026

coordinamento marketing Antica Ceramica Rubiera

progetto G&CO creatività adattiva

stampa Grafiche Antiga



www.anticaceramica.it

In nessuna circostanza Antica Ceramica Rubiera sarà responsabile di danni diretti o indiretti che possano derivare dall'uso improprio di qualsiasi prodotto e/o da eventuali modifiche sui prodotti che possono essere applicate senza alcun preavviso. Questo catalogo è protetto da copyright e da altri diritti di proprietà intellettuale. I colori illustrati sono puramente indicativi Antica Ceramica Rubiera si riserva il diritto di modificare lo stile, il confezionamento e i colori dei propri prodotti senza preavviso. Siete quindi invitati a consultare di tanto in tanto i rappresentanti locali di Antica Ceramica Rubiera in merito ai prodotti, programmi e servizi disponibili nella vostra zona. Il materiale di questo catalogo può contenere informazioni imprecise ed errori di battitura. Antica Ceramica Rubiera declina ogni responsabilità in merito a perdite o danni causati o associati all'affidamento fatto dagli utenti sulle informazioni contenute nel catalogo.

Under no circumstance shall Antica Ceramica Rubiera be liable for any direct or indirect damage which may occur due to the improper use of any product and/or due to eventual changes on the products which can be applied without any notice. This catalogue is protected by copyright and by other intellectual property rights. The colors illustrated in this catalogue are merely illustrative Antica Ceramica Rubiera reserves the right to change the style, packaging and colours of the products without prior notice. Therefore, you are invited to consult Antica Ceramica Rubiera's local representatives from time to time concerning the products, marketing and services which are available in your country. The material in this catalogue may contain inaccurate informations and typing errors. Antica Ceramica Rubiera declines all liability concerning losses or damage caused by or associated with the reliance made by the users on information contained in the catalogue.

Antica Ceramica Rubiera ne peut en aucun cas être tenue responsable des dommages directs ou indirects pouvant résulter de l'utilisation non conforme d'un produit et / ou de toute modification des produits pouvant être appliquée sans préavis. Ce catalogue est protégé par le droit d'auteur et d'autres droits de propriété intellectuelle. Les couleurs présentées sont purement indicatives Antica Ceramica Rubiera se réserve le droit de changer le style, le conditionnement et les couleurs de ses produits sans préavis. Vous êtes donc invités à vérifier de temps en temps avec nos agents d'usine locaux de Antica Ceramica Rubiera les produits, programmes de vente et services disponibles dans votre région. Le contenu de ce catalogue peut contenir des informations inexactes et des fautes de frappe. Antica Ceramica Rubiera décline toute responsabilité pour les pertes ou dommages causés ou associés à la cession faite par les utilisateurs aux informations contenues dans le catalogue.

Unter keinen Umständen kann Antica Ceramica Rubiera für direkte oder indirekte Schäden verantwortlich gemacht werden, die sich aus der missbräuchlichen Verwendung eines Produkts und / oder Änderungen der Produkte ergeben, die ohne vorherige Ankündigung angewendet werden können. Dieser Katalog ist durch das Urheberrecht und andere geistige Eigentumsrechte geschützt. Die gezeigten Farben sind rein indikativ Antica Ceramica Rubiera behält sich das Recht vor, Stil, Verpackung und Farben seiner Produkte ohne vorherige Ankündigung zu ändern. Sie können daher von Zeit zu Zeit mit dem Antica Ceramica Rubiera-Vertreter zu den in Ihrem Gebiet verfügbaren Produkten, Programmen und Dienstleistungen prüfen. Das Material in diesem Katalog kann ungenaue Informationen und Tippfehler enthalten. Antica Ceramica Rubiera lehnt jede Haftung für Verluste oder Schäden ab, die durch die Zuordnung der Benutzer zu den im Katalog enthaltenen Informationen verursacht wurden.



Ceramics of Italy



Antica Ceramica Rubiera S.r.l.

Via Salvaterra, 18/A - 42048 Rubiera (RE) - Italy
Tel. +39 0522 628841 - Fax +39 0522 628976 - info@anticaceramica.it
www.anticaceramica.it

